



**BRUAG**  
Innovation for Architecture

# Sliding, Folding & Shading Elements

CELLON<sup>®</sup> design, classic

Technical data sheet for planning,  
construction and execution

A.4

Version 3.0

# Table of Contents

---

## General Information

01.

- Material
- Panel Formats
- Data Transmission for Orders
- Storage and Cleaning Instructions
- Cutting and Drilling Guidelines

P.1  
P.1  
P.2  
P.2  
P.2

---

## Fastenings

02.

- Fastening Distances
- Fasteners

P.3  
P.4

---

## Substructure

03.

- Substructure for Screwed Panels
- Substructure for Clamped Panels
- Substructure for Plugged Panels

P.5  
P.5  
P.5

---

## Construction Solutions

04.

- Window Shutters
- Sliding Shutters
- Folding Sliding Shutter

P.7  
P.8-10  
P.11

---

## Design

05.

- Our Collection

P.12

# General Information

01.

## Material

Our **CELLON®** panel is a high-pressure laminate panel (HPL Compact or solid core panel) consisting of 70% cellulose webs and 30% phenolic resin. The extremely weather and frost-resistant material is ideal for outdoor applications.

- Application area:** mounted vertically in outdoor areas (e.g. facades, balcony railings)
- Panel thickness (weight):** 8mm (approx. 12kg/m<sup>2</sup>), 10mm (approx. 15kg/m<sup>2</sup>)
- Reaction to fire class:** RF2, B1 (DIN 4102-1), B-s1-d0 (EN 13501-1)

The raw panels are project-specifically cut to the desired dimensions using laser technology (including drill holes). You choose the **width (x)** and the **length (y)** of the panels individually. Do you want round cuts or additional cut-outs? Simply draw them in your DXF plan and they will be **manufactured to size**.

## Panel Formats

Please consider the following raw panel formats for waste optimisation:

perforated panels

### CELLON® design

Raw width	Raw length
1200 mm	2400 mm
1280 mm	3000 mm *
1500 mm	3600 mm
1800 mm	3600 mm

plain panels

### CELLON® classic

Raw width	Raw length
1200 mm	2400 mm
1280 mm	3000 mm *
900 mm	3600 mm

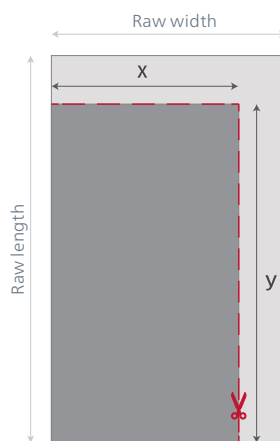
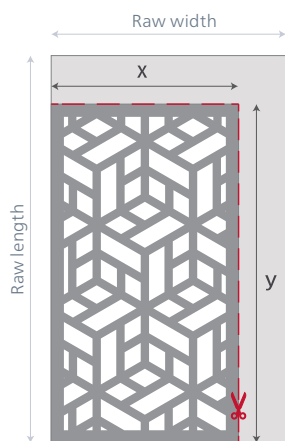

### Note

Whenever possible, the raw material sizes should be considered when planning the panel layout so that panel waste can be minimised. We support you with this.

\*Only this format is also available with a decor surface in stone or wood look.

# General Information

01.

## Data Transmission for Orders

Please note the following when placing an order:

### Data Format

- DWG / DXF Data
- Cadwork 2D or 3D Data
- Parts lists in Excel (if only as Excel without CAD file is sent, it might result in additional work in our work preparation)

### Data Content and Structure

- Panels are drawn on a separate layer
- Drawing in 1:1 ratio
- Measurement of at least one long and short side to be able to verify the scale
- Boreholes (drawn as a closed circle), cut-outs, etc. are marked accordingly
- Special requests for grouping and/or palletisation must be explicitly specified. Normally there is room on one pallet for 120 square metres of panels. Within the pallet there is no sorting by panel numbers etc.

### Own Design (the following specifications must be observed for own designs)

- Design must be created as CAD drawing (DWG or DXF file)
- Contours must be neatly closed and drawn as a line (not several lines on top of each other)
- Size ratio must be clearly visible

In the event of post-processing by Bruag Design Factory AG, the resulting additional work will be invoiced.

## Storage and Cleaning Instructions

CELLON® panels must never be stored unprotected horizontally outdoors. If water remains on the horizontally lying panels, damage to the paint may occur! Please always place the dry PU foam foils supplied as a separating layer between the individual boards.

The boards can be cleaned with water and a cloth or magic sponge. Careful use of a high-pressure cleaner is also possible with sufficient distance and little pressure. Do not use any chemical cleaning agents.

## Cutting and Drilling Guidelines

Basically, cutting to size on site should be avoided and the panels should already be ordered to the project-specific size whenever possible. However, in exceptional cases it is possible to process the panels on site, with the note that the panels are coated and the cut edge will therefore not have the same colour after cutting as the surface. Tools with carbide cutting edges or diamond cutting edges are advantageous as cutting items. The visible side should be at the top when cutting and, if possible, a guide rail should be used.

Spiral or dowel drills made of solid carbide are ideally used for drilling.

The material does not require post-treatment from the point of view of weather protection. However, if necessary, the edge can be coated with the supplied reserve paint.

# Fastenings

02.

## Fastening Distances

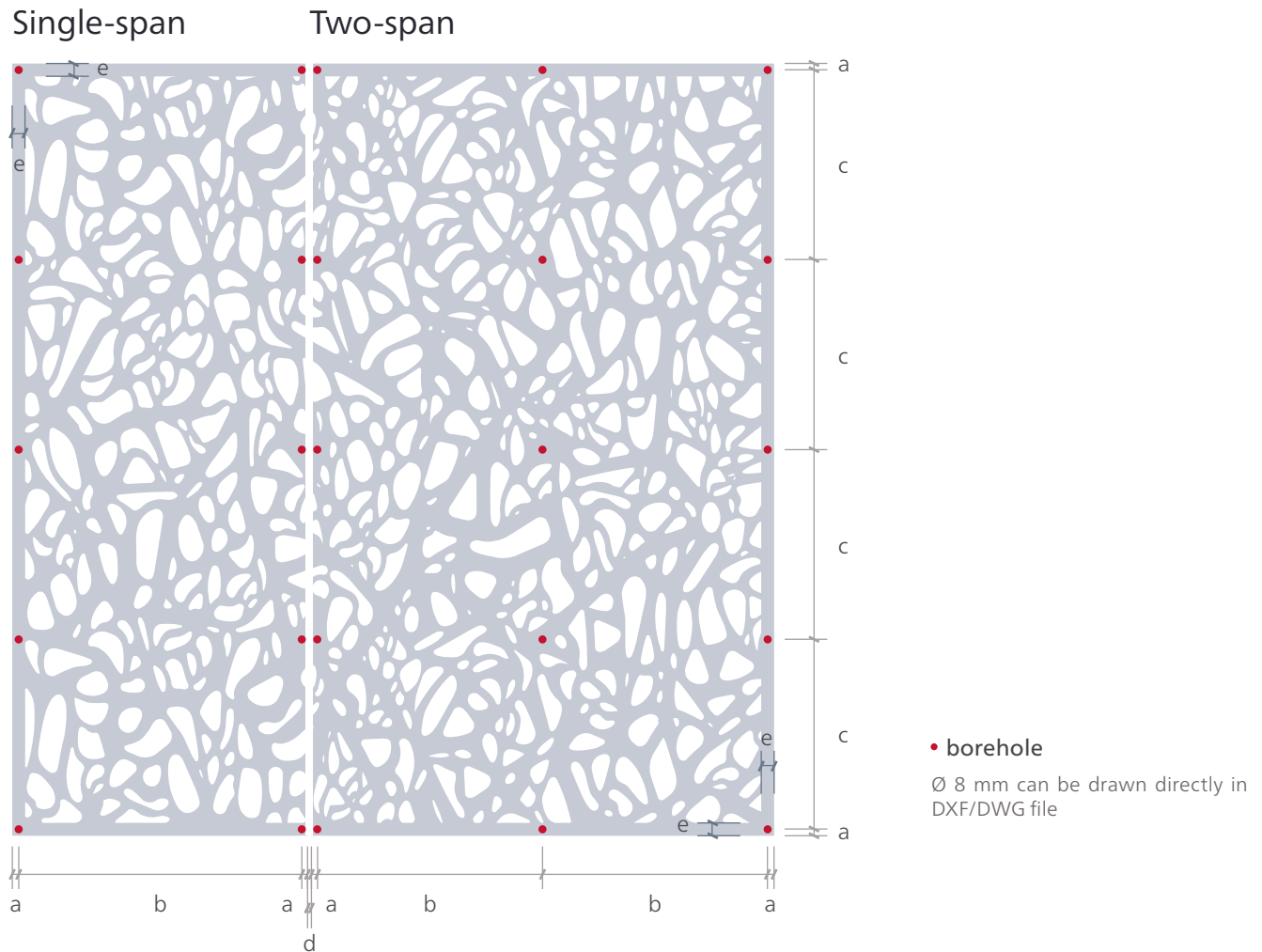

Maximum distance according to wind load  $q_{ek}$  (wind pressure or suction)

Position in mm	Description	CELLON® 8mm				CELLON® 10mm			
		0.5 kN/m <sup>2</sup>	1.0 kN/m <sup>2</sup>	1.5 kN/m <sup>2</sup>	2.0 kN/m <sup>2</sup>	0.5 kN/m <sup>2</sup>	1.0 kN/m <sup>2</sup>	1.5 kN/m <sup>2</sup>	2.0 kN/m <sup>2</sup>
a	Distance borehole to edge	20				20			
b	Horizontal borehole distance	970	815	735	685	1300	1200	1030	890
c	Vertical borehole distance	645	465	350	235	290	170	130	115
d	Joint	6				6			
e	Frame without perforation	50				50			

**Reciprocal conversion:**

$$c \text{ (adjusted)} = b \text{ (max)} / b \text{ (effectiv)} \times c \text{ (max)}$$

$$b \text{ (adjusted)} = c \text{ (max)} / c \text{ (effectiv)} \times b \text{ (max)}$$

The values given are guidelines and do not release you from having an object-related inspection carried out by a qualified engineer. Test results for the tests according to EN 789, EN1048, EN 14358, EN 383, EN 1383, EN 310 and EN 13879 can be found in a separate test report.

# Fastenings

02.

## Fasteners

### Metal Substructure

#### Hexagon-head screw (self-drilling with sealing washer)

Material:	Stainless steel A2 (with drill point and shaped thread made of hardened steel)
Length:	32 mm
Nominal diameter:	5.5 mm
Head diameter:	16 mm
Drives:	SW8, hexagon head
Borehole diameter:	8 mm



#### Blind Rivet

Material:	Aluminium/Stainless steel A2
Length:	8-13 mm
Nominal diameter:	5.0 mm
Head diameter:	14 mm
Drives:	Blind rivet tool
Borehole diameter:	8 mm



### Note

Screws and rivets are to be placed concentrically in the drilled holes.  
**NO COUNTERSUNK SCREWS MUST BE USED!**



# Substructure

03.

## Substructure for Screwed Panels

at the Edge

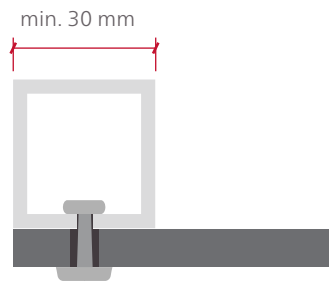

in Joint Area

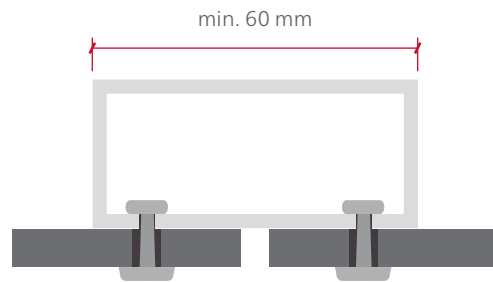

## Substructure for Clamped Panels

at the Edge

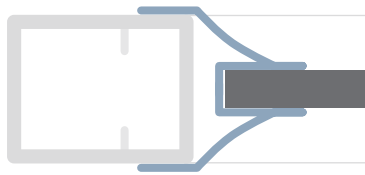

in Joint Area

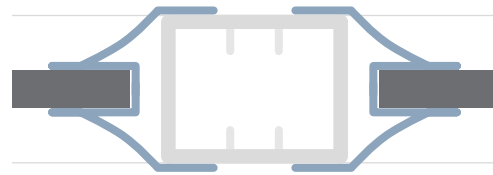

## Substructure for Plugged Panels

at the Edge

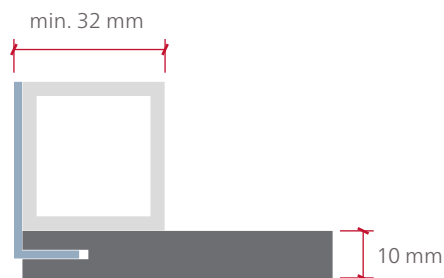

in Joint Area

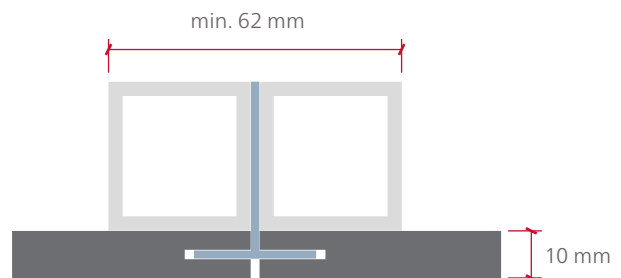

# Construction Solutions

# 04.

For the play of light and shadow. CELLON® design panels are very well suitable for sliding or folding applications. The customized panels are fixed on a metal frame, which is directly installed on the facade with the respective sliding or folding fittings. Due to the low weight of the perforated CELLON® panels (ca. 7-9kg/m<sup>2</sup>) the handling of the elements is as easy as it can be.

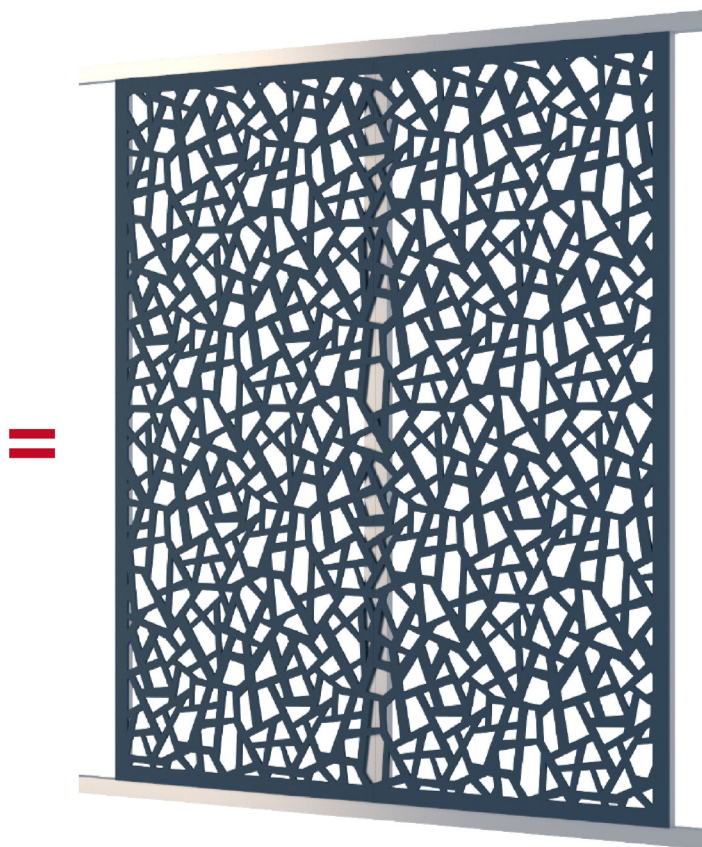
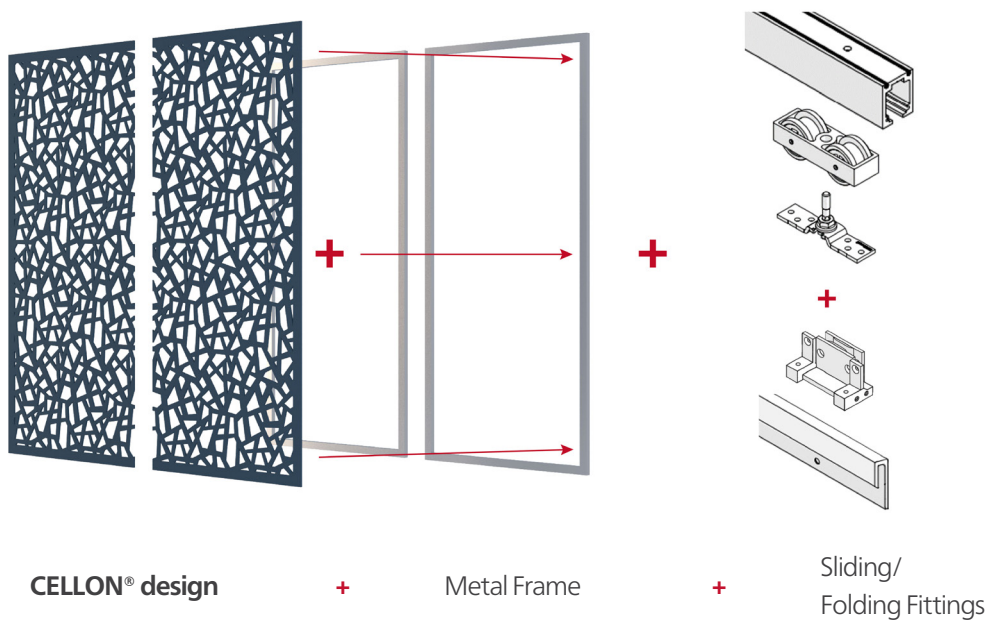

Sliding/Folding Element



# Construction Solutions

# 04.

## Window Shutters

Conventional Wall Mounting



Mounting on Frame



Mounting on Sub-frame



Pintel

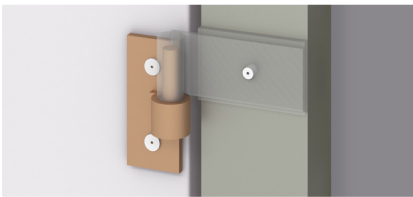

Hinge



Wall Mounting

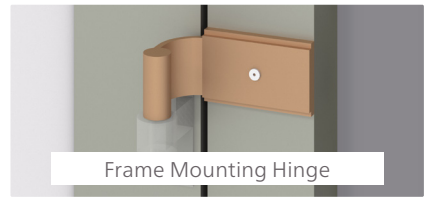

Frame Mounting Hinge

The pintels are the fixed part of the "hinge", which provides the pivot point of the sash. Depending on the structural conditions, different pintels must be used. These must always be mounted tightly with the product-specific specifications of the manufacturer being observed.

The hinges are the counterpart of the pintel. They are attached to the frame of the folding shutter. Here, too, there are different designs and manufacturer's specifications that must be taken into consideration.



# Construction Solutions

04.

## Sliding Shutters

### Simple Sliding Element

#### Ceiling and Floor Mounting

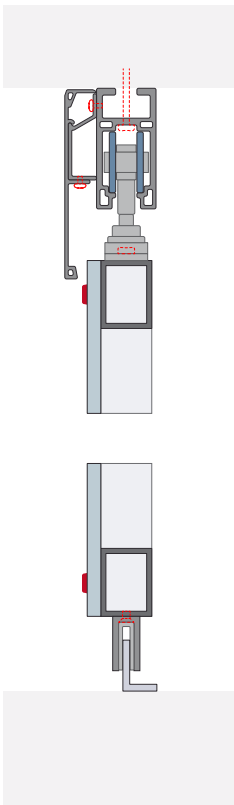

#### Wall Mounting

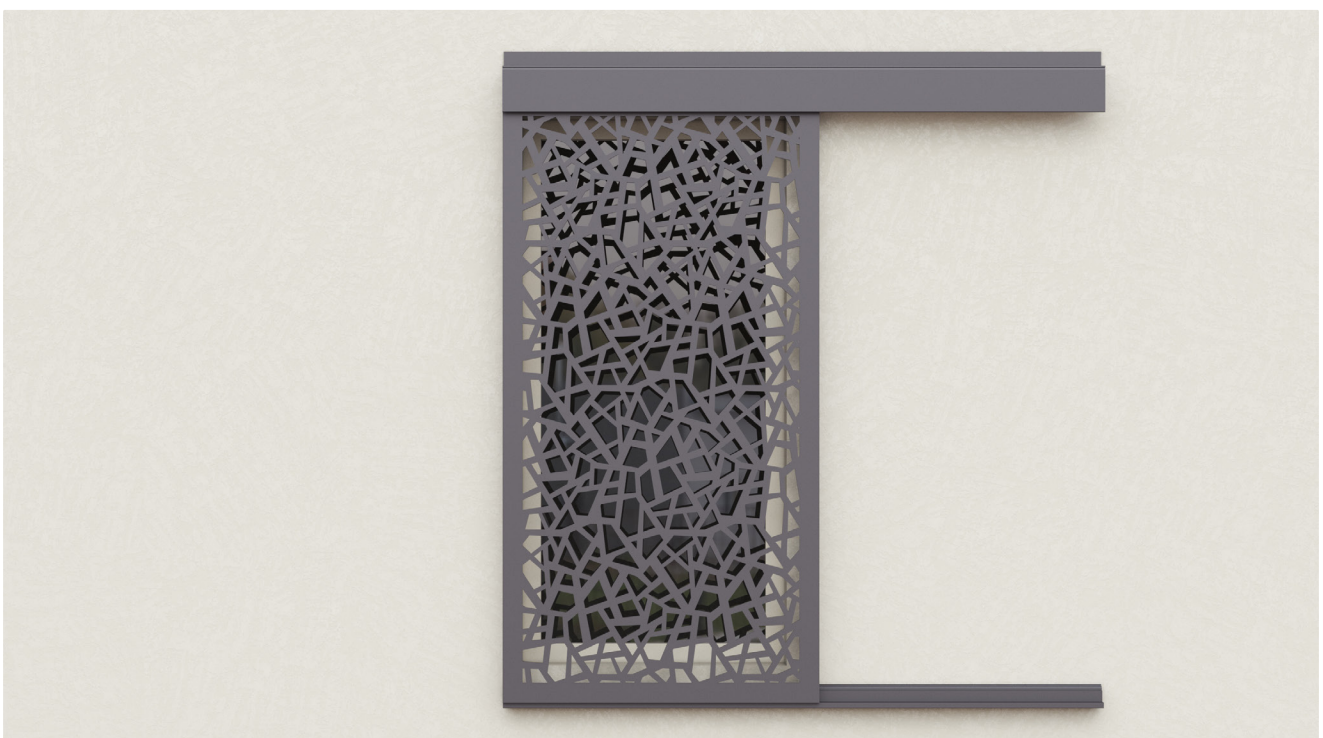
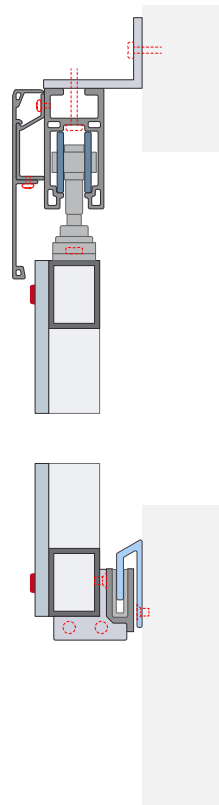

# Construction Solutions

04.

## Symmetrical Sliding Element

Ceiling and Floor Mounting

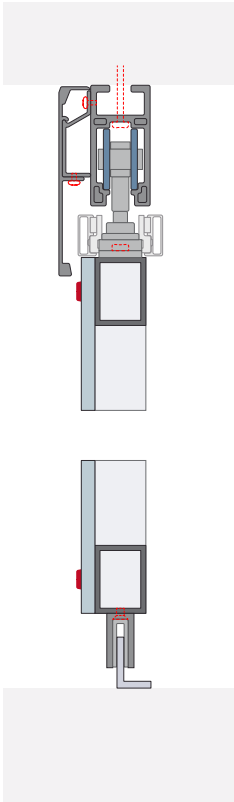

Wall Mounting

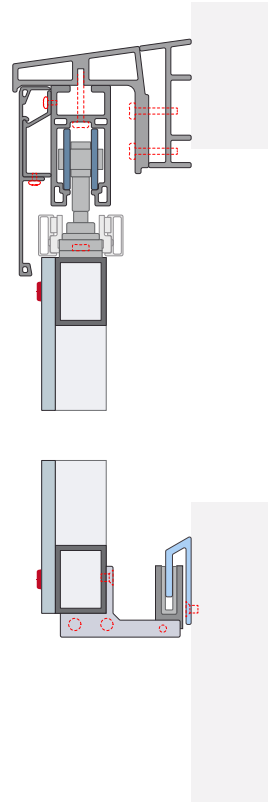

# Construction Solutions

04.

## Telescopic Sliding Element

### Ceiling and Floor Mounting

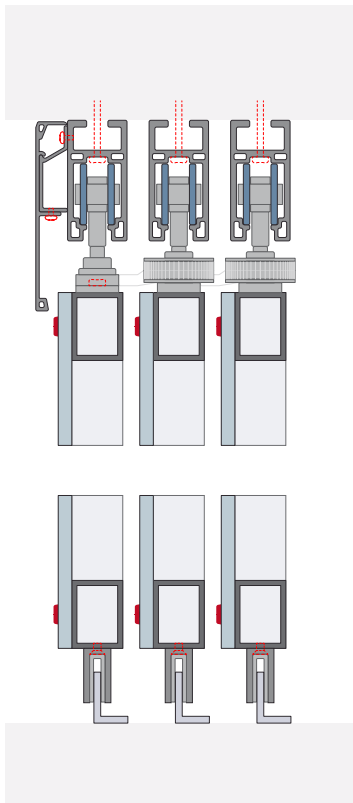

### Wall Mounting

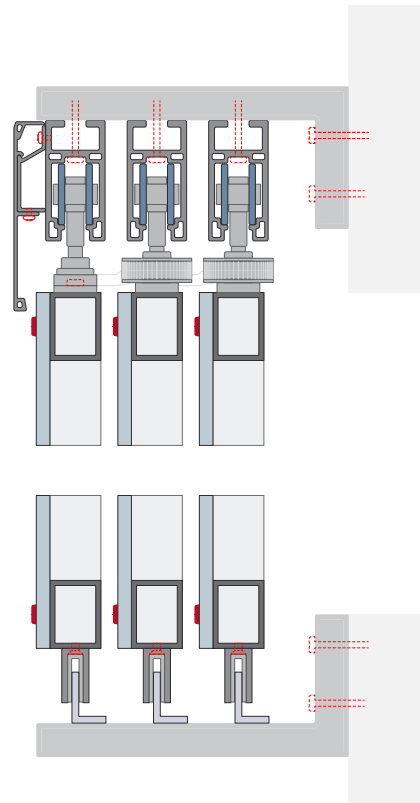

# Construction Solutions

04.

## Folding Sliding Shutter

Ceiling and Floor Mounting

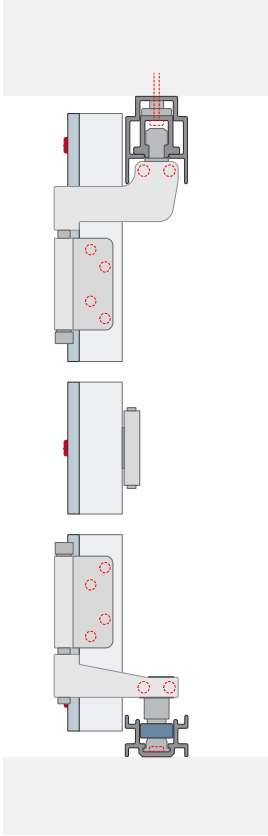

Wall Mounting

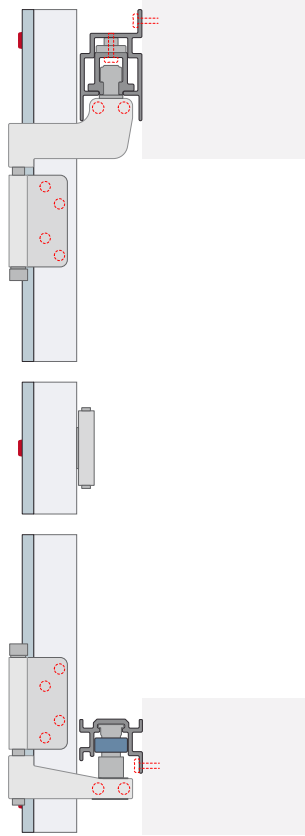

Folding Hinges Options

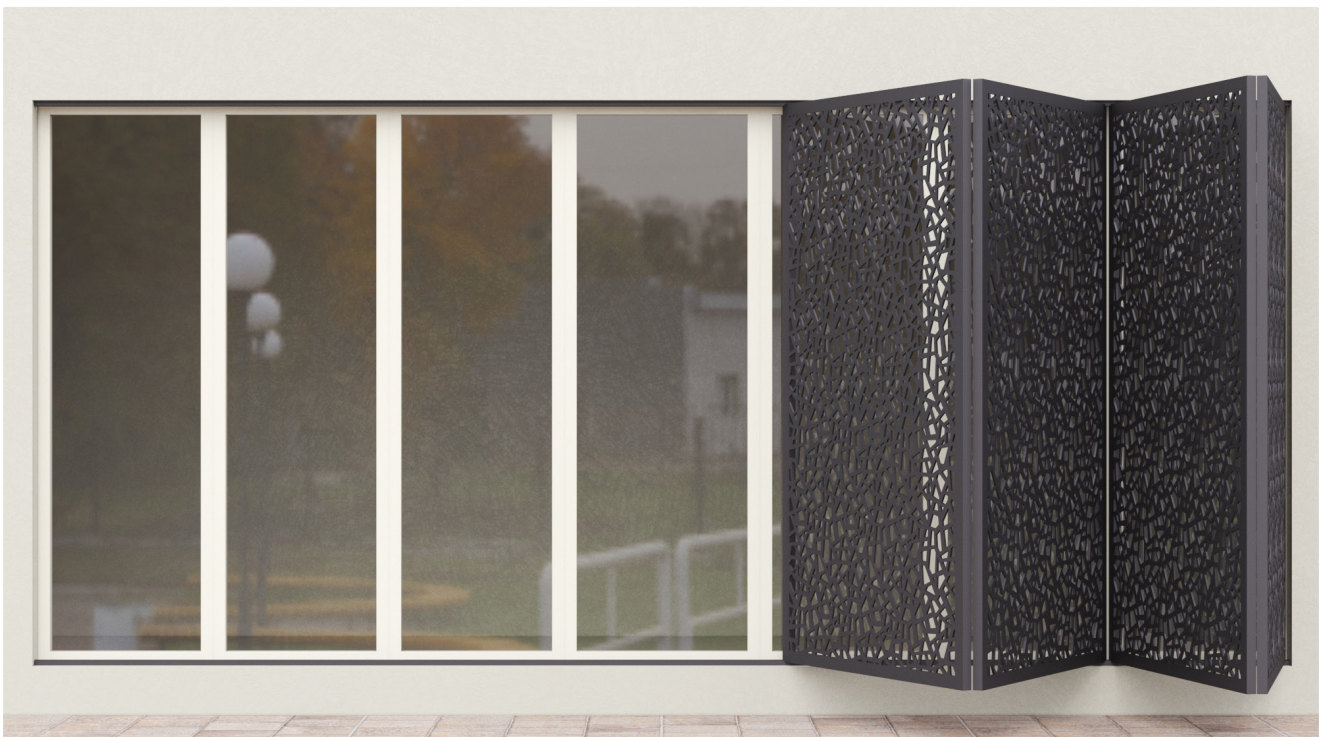
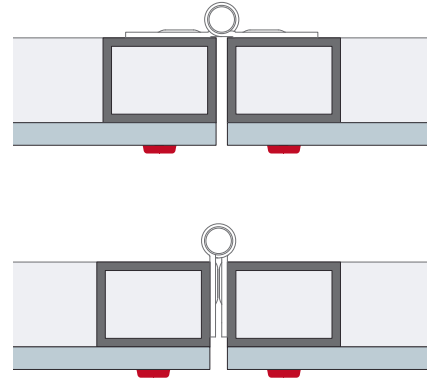

# Design

05.

You can find the entire perforation collection in our catalogue.

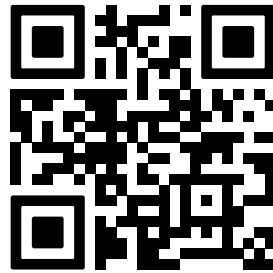

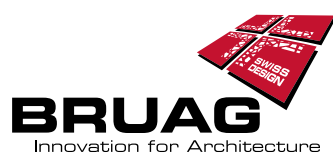

**Bruag Design Factory AG**  
Switzerland

☎ +41 71 414 00 90

✉ [info@bruag.ch](mailto:info@bruag.ch)

🌐 [www.bruag.ch](http://www.bruag.ch)